

MZ-5600 Service Checker

MZ - 5600 MFD Checker

Operation Manual

INDEX

I.	MZ-5600 SERVICE CHECKER	
I-1.	General.....	1
I-2.	Tools Required.....	1
I-3.	Test System Block Diagram.....	1
I-4.	MZ-5600 Service Checker Operational Procedure...	2
II.	MZ-5600 MFD CHECKER INSTRUCTIONS	
II-1.	General.....	19
II-2.	ROM Exchange Procedure and Setup.....	19
II-3.	Main Menu.....	20
II-4.	Independent Test Function.....	21

I. MZ-5600 SERVICE CHECKER

I-1. General

This service checker is used to test the system performance of the MZ56310/41/45 using the program contained on the floppy disk.

I-2. Tools required

- 1) 1D10 (640 x 400 monochrome display unit)
- 2) 200-raster color display unit
- 3) Printer
- 4) Keyboard (MZ5500 keyboard may be used)
- 5) RS232C checker cable
- 6) Service check program diskette
- 7) Blank floppy disk (640K x 2)

I-3. Test system block diagram

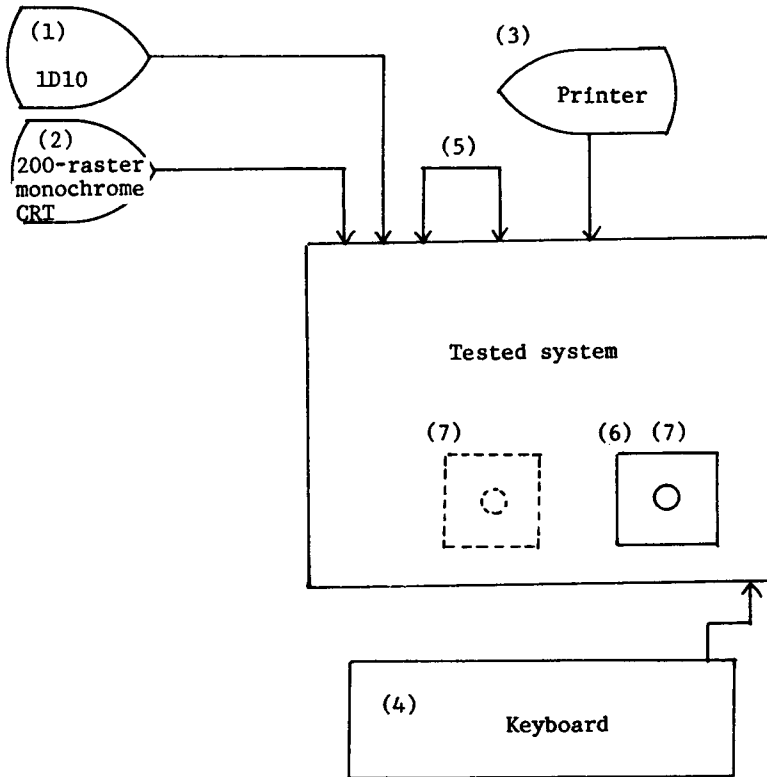

I-4. MZ5600 service checker operational procedure

°The MZ5600 service checker consists of the following two parts:

- i) Service checker I which permits to test 12 test item menu.
It has the file name of "S".
- ii) Service checker II which is used to test timer function. For execution of this program, power has to be turned off after the execution of the service checker I and turned on again. It has the file name of "T".

(1) Service checker I (file name: S)

Depression of the [S] and [CR] keys after initiation of CP/M86, the following menu is prompted calling for an entry of the name name to be tested.

MZ-5600 SERVICE CHECKER PROGRAM	
VERSION 1.0A	
MZ-5631	—————> 0
MZ-5641	—————> 1
MZ-5645	—————> 2
Please key in 0/1/2=	

This item checks the following device capacity.

	MFD	HD	DRAM	VRAM
MZ5631	640K x 1	No	256KB	92KB
MZ5641	640K x 2	No	256KB	92KB
MZ5645	640K x 1	1	256KB	92KB

As test items are now prompted on display, the desired test number must be specified. After the given test has been successfully completed, the control then returns to the menu again. Enter [E] to terminate the test.

(2) Service checker II (file name: T)

As the test item "TIMER" of the service checker I has been executed, power must turned off. Wait for ten seconds, then turn power on to go into this test phase. When the [T] and [CR] keys are depressed after initiation of CP/M-86, the contents of the internal timer are read.

1. RAM & IPL ROM tests

This test item can be assigned by the depression of the [1] [CR] keys in the main menu.

i) RAM test

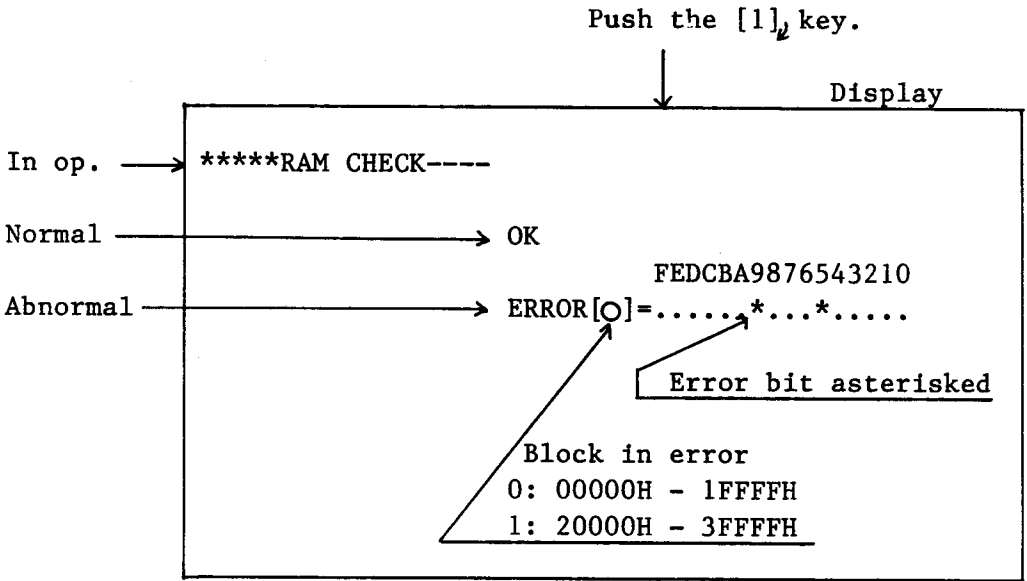

ii) IPL ROM test

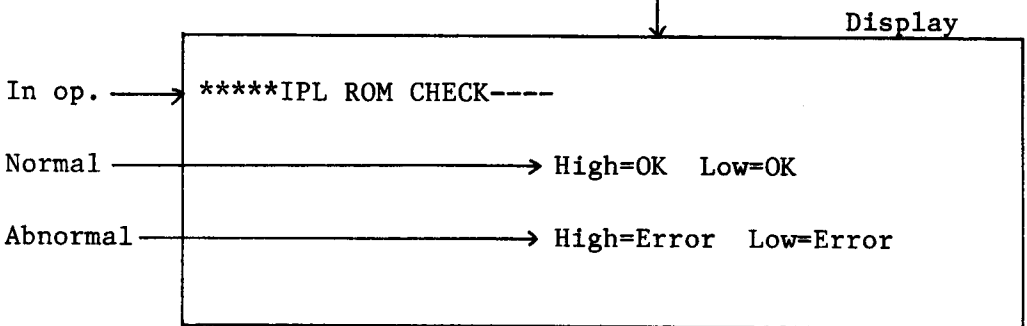

Test results are displayed for high order byte and low order bytes, respectively.

Depression of the [SPACE] bar after completion of test items i) and ii) will cause the control to return to the main menu.

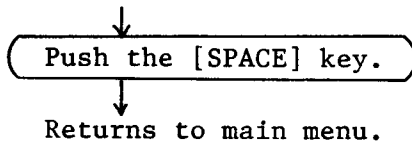

2. Sound interface, audio out, speaker tests

Depress the [2] [CR] keys to choose this menu.

i) Single sound and chord generation

Push the [2] key.

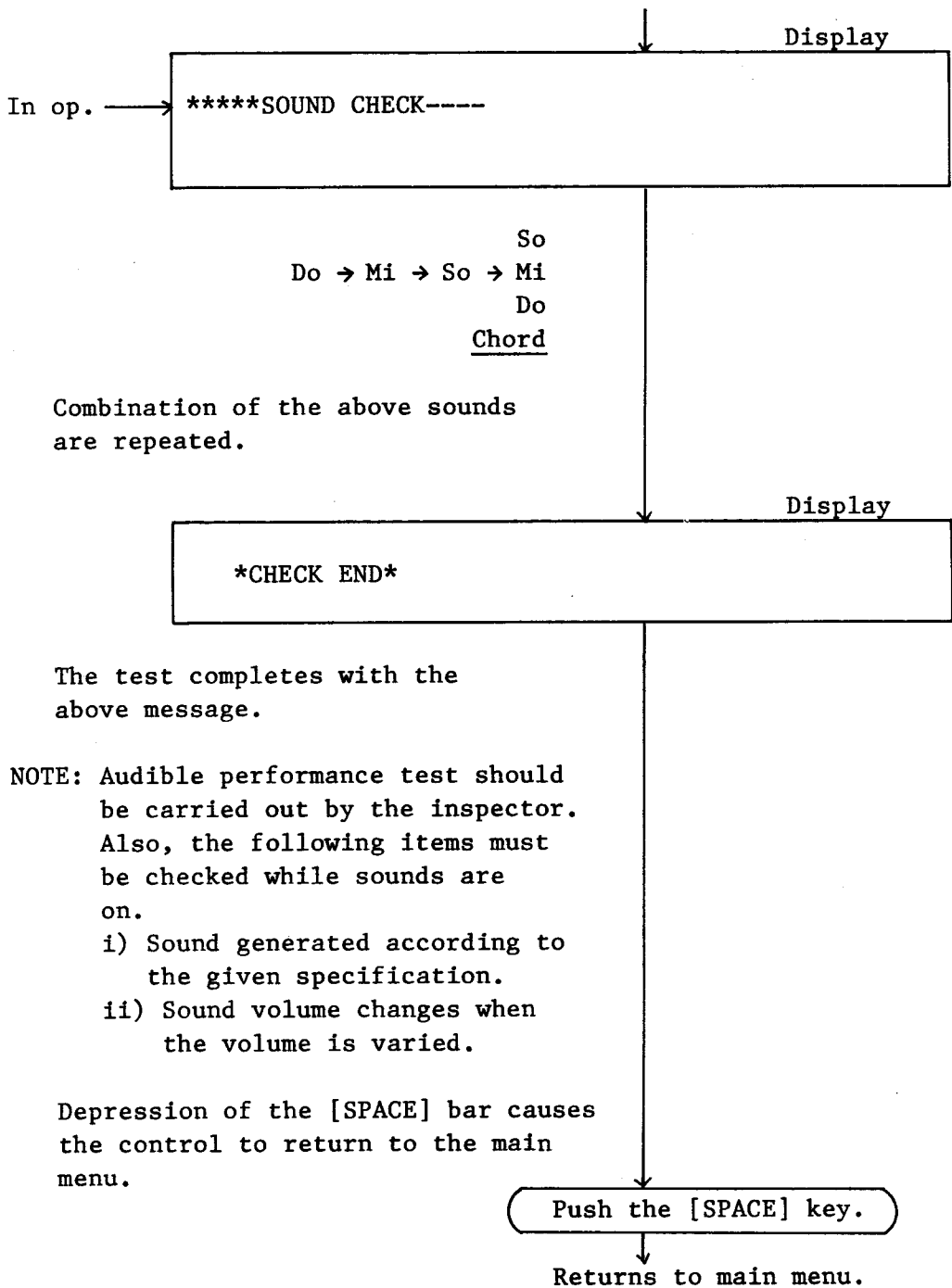

3. VRAM test

This test item can be assigned by the depression of the [3] [CR] keys in the main menu.

i) VRAM test

An entire screen area is colored white three times after the execution.

Push the [3] key.

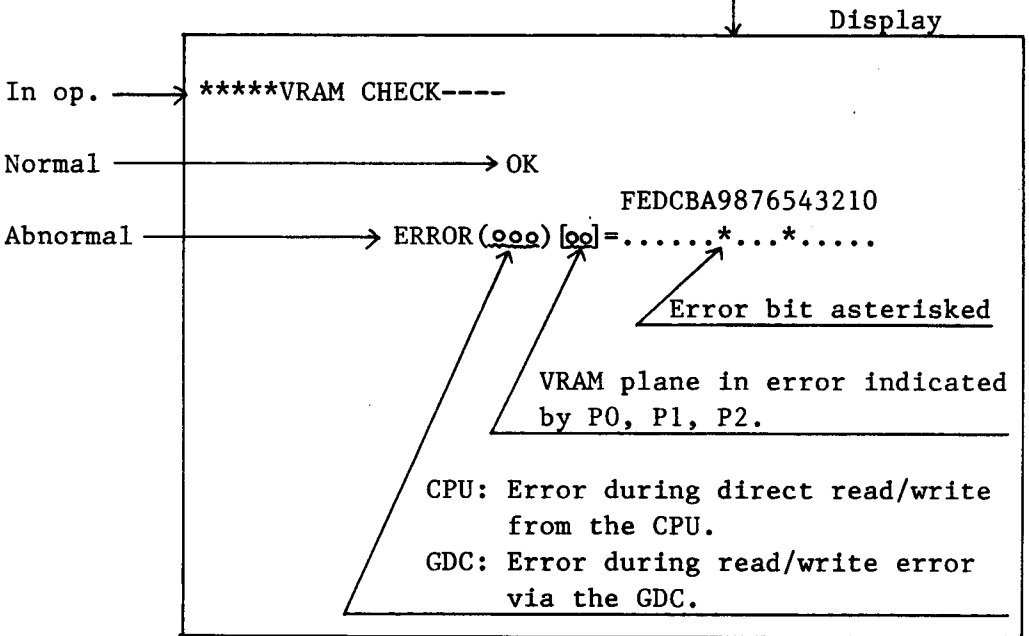
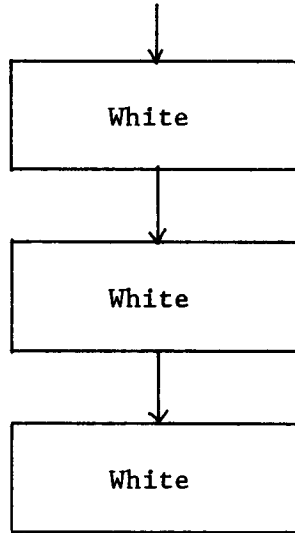

Depression of the [SPACE] bar after completion of test items cause the control to return to the main menu.

Push the [SPACE] key.

Returns to main menu.

4. Display tests

4-0. Move of window

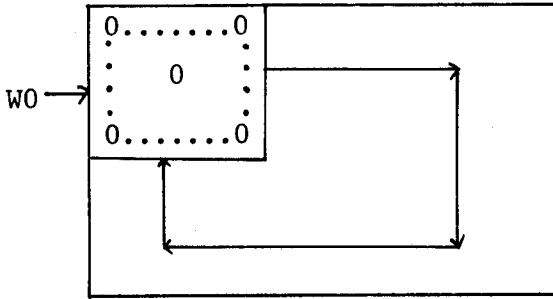

As shown in the figure, window is moved on the screen.

The time required to run one window will be about one second.

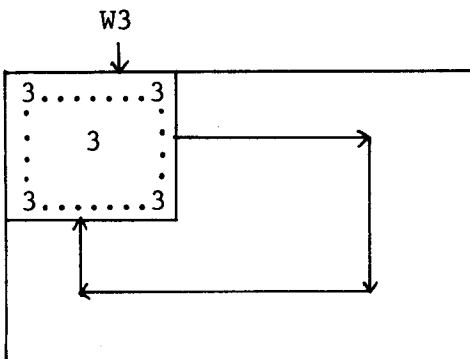
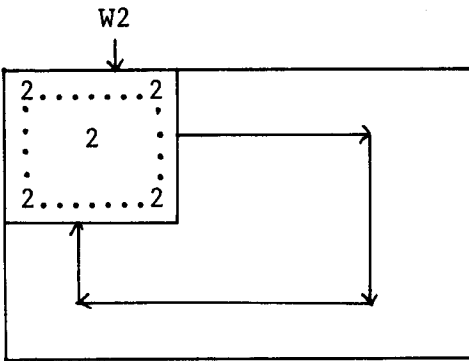
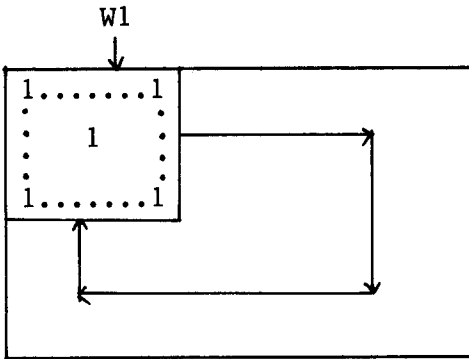

4-1. Pattern generation

- i) When the program is started, the pattern shown in Fig.4-1 appears.

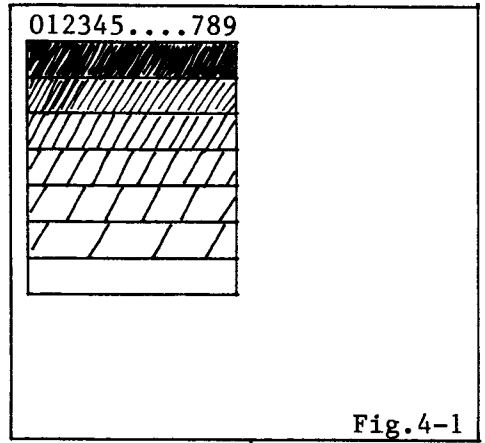

SPACE bar x 4

4-2. Window display test

- i) Each time the [SPACE] key is depressed, pattern in Fig.4-2 appears in turn. Four depressions makes all four patterns displayed. Check appearance of pattern in their order.

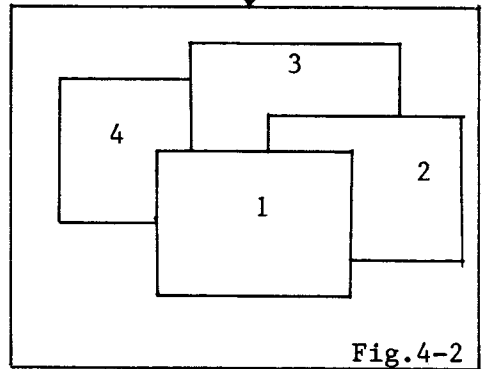

SPACE bar

4-3. Color priority test

- i) Push the [SPACE] bar and make sure that the pattern in Fig.4-3 appears.

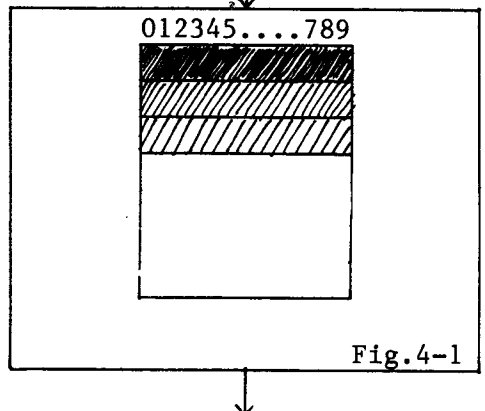

4-4. Pallet test

i) Push the [SPACE] bar to check that an entire screen turns black.

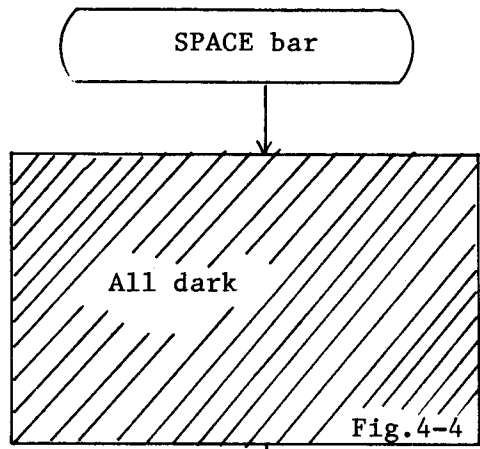

ii) Push the [SPACE] bar to check that an entire screen turns white.

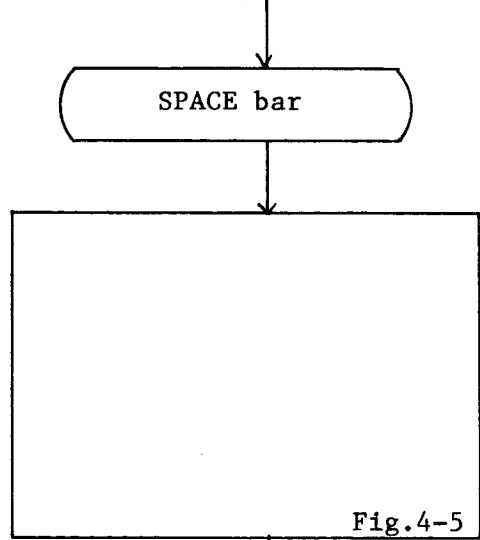

iii) Push the [SPACE] bar to check that it returns to the window display mode.

4-3. Color priority test

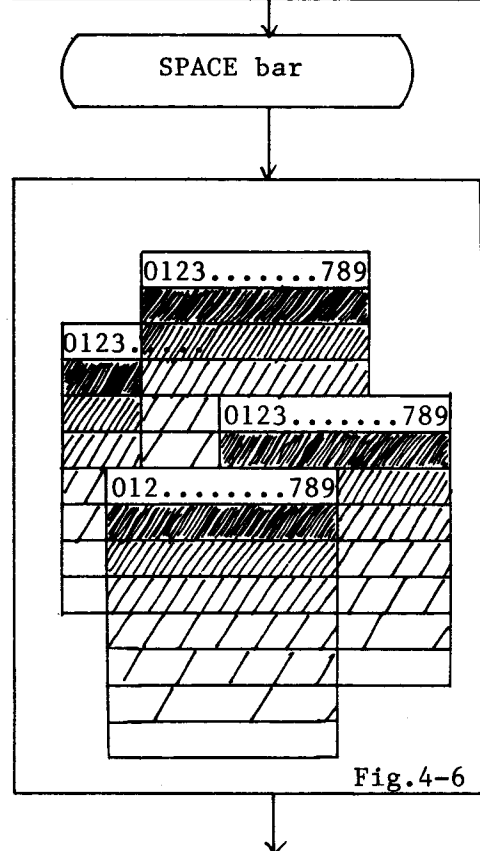

4-5. Background color test

- i) Push the [SPACE] bar to pad windows with numbers with the background in white. As a result, a white block is displayed as in Fig.4-8.

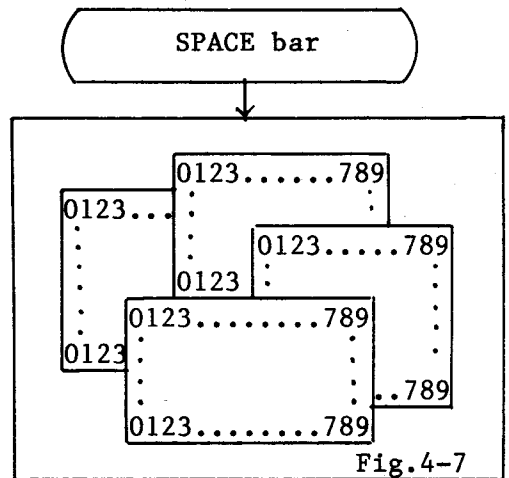

Fig.4-7

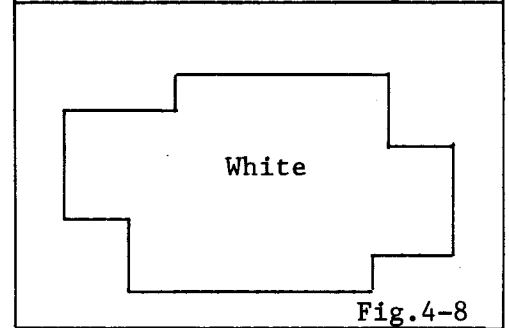

Fig.4-8

4-6. Monochrome reverse test

- i) Push the [SPACE] bar and check that the white area in Fig.4-8 are padded with numbers.

NOTE:

Figures are displayed in white on the black background.

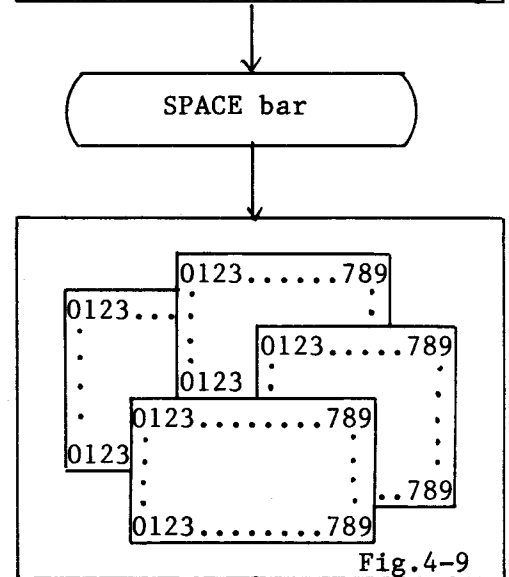

Fig.4-9

- ii) Push the [SPACE] bar to invert color of figures with numbers displayed in reverse video.

NOTE:

Numbers are displayed in black on the white background.

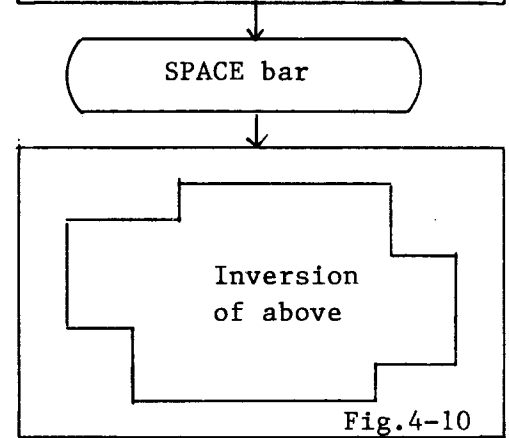

Fig.4-10

4-7. VDS test

- i) Depression of the [SPACE] bar displays four windows; each one having different brightness (Fig-11).

NOTE:

Make sure the brightest window is on the bottom.

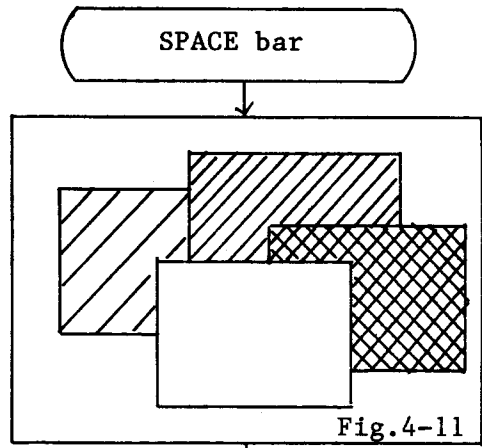

- ii) Depression of the [SPACE] bar changes contrast of each window.

NOTE:

Make sure that the brightest window is on the right.

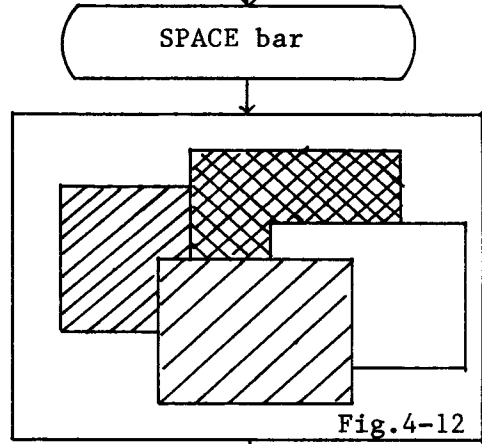

- iii) Depression of the [SPACE] bar changes contrast of each window.

NOTE:

Make sure that the brightest window is on the top.

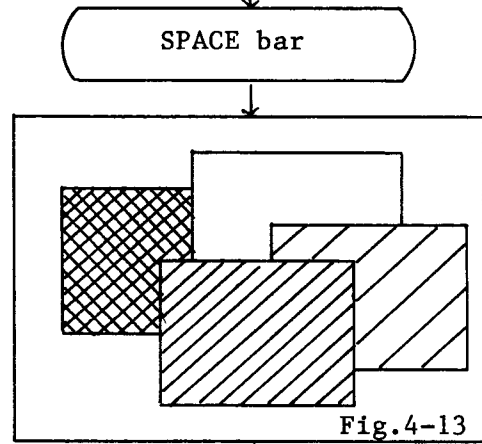

- iv) Depression of the [SPACE] bar changes contrast of each window.

NOTE:

Make sure that the brightest window is on the left. Also, make sure for the window priority check function appearing next that the bottom window is the brightest.

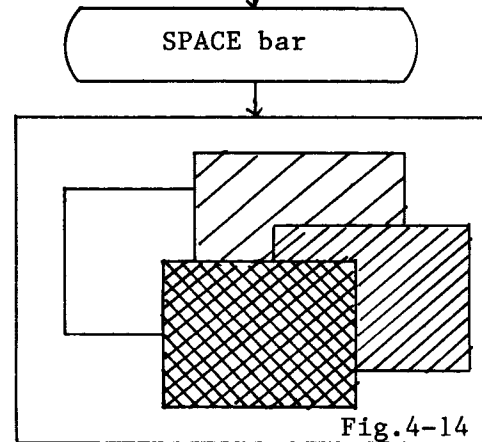

4-8. Window priority test

i) Depression of the [SPACE] bar changes the window display priority as shown in Fig.4-15.

NOTE:

Make sure the brightest window is on the third window from the top.

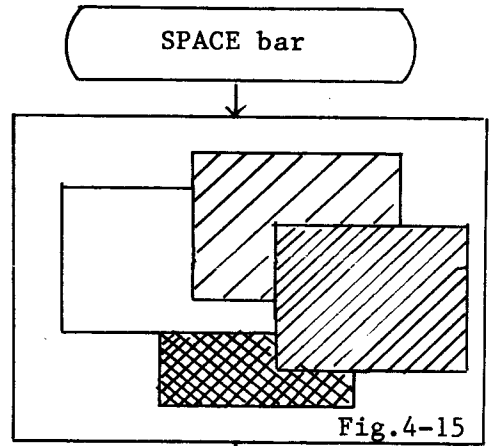

ii) Depression of the [SPACE] bar changes the display priority as in Fig.4-16.

NOTE:

Make sure that the brightest window is on the second from the top.

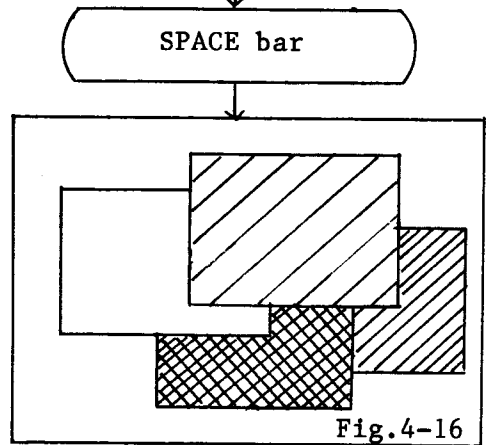

iii) Depression of the [SPACE] bar changes the display priority as in Fig.4-17.

NOTE:

Make sure that the brightest window is on the top.

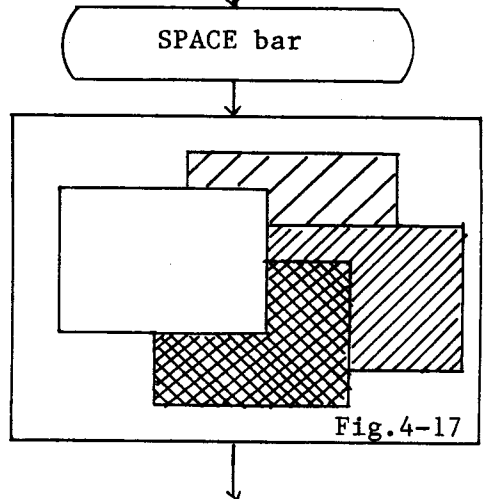

4-9. Display resolution change and border color tests

i) Depress the [SPACE] bar to display the menu shown in Fig.4-18.

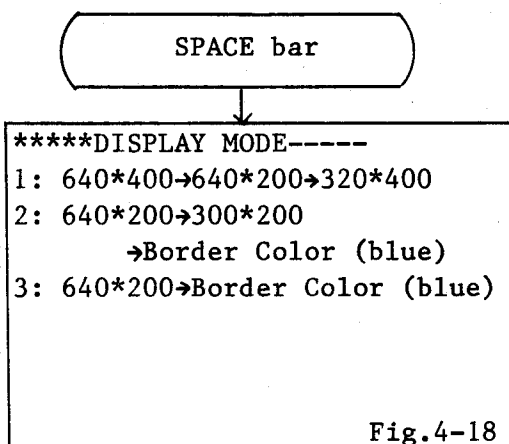

ii) Depress the [1] key. Numbers are displayed in four windows in the 600*400 mode.

NOTE:

The brightest window at this stage should be the window at the bottom.

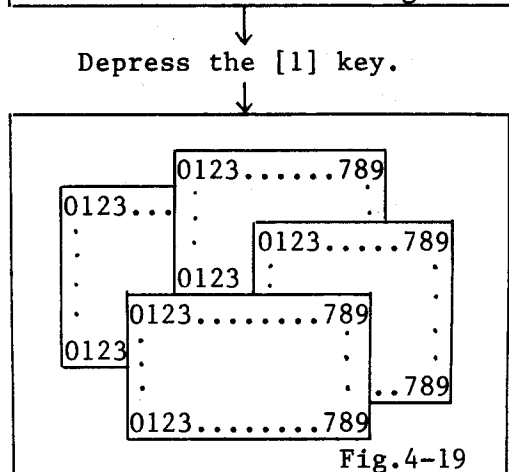

iii) Depression of the[SPACE] bar will display in the same manner as in Fig.4-19 in the 640*200 mode. But, characters become displayed more coarsely.

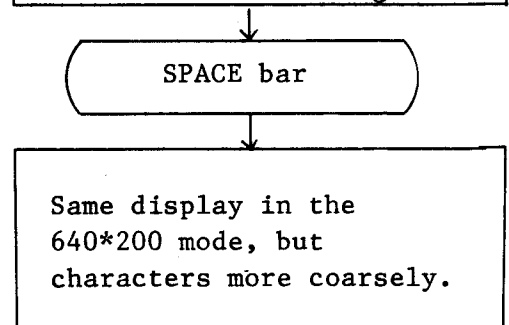

iv) Depression of the [SPACE] bar will display in the same manner as in Fig.19 in the 320*400 mode. But, make sure that each character is expanded twofold in its width, reducing display capacity into a half.

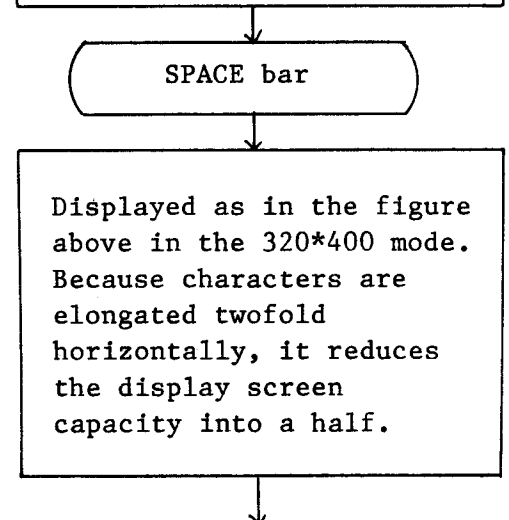

v) Depression of the [SPACE] bar terminates the test No.1 and it returns to the menu in Fig.4-18.

vi) Depress the [2] key. It changes to the 200-raster mode. Make sure that four windows are displayed with each window displayed in white, blue, red, and green, respectively, in the 640*200 mode.

vii) Four windows are displayed in white, blue, red, and green in the 320*200 mode. Because a single character is elongated twofold in horizontally, make sure that the display capacity is reduced into a half.

viii) Border color test Make sure that depression of the [SPACE] bar changes the border blue as shown in Fig.4-21.

ix) Depression of the [SPACE] bar terminates the test No.2 and it returns to the menu in Fig.18.

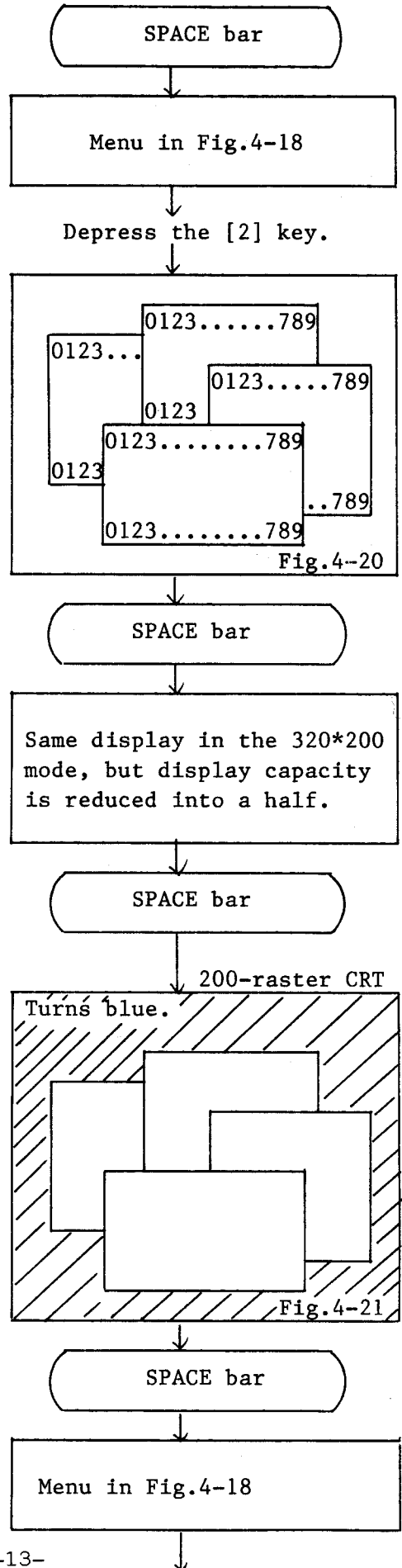

- x) Push the [E] key to terminate the resolution change test and the border color test.

4-10. Program run on VRAM

- 1) Make sure that "V-RAM PROGRAM RUN OK" is displayed.

4-11. Termination of display test

- 1) Depress the [SPACE] bar to terminate the display performance tests. The control then returns to the main menu. is reduced into a half.

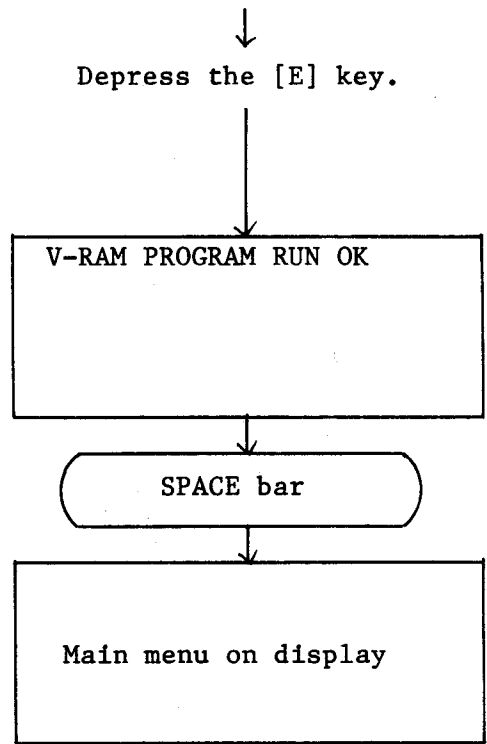

7. RS-232C interface test

Push the [8] key in the main menu to assign this test item.

Depress the [8] key.

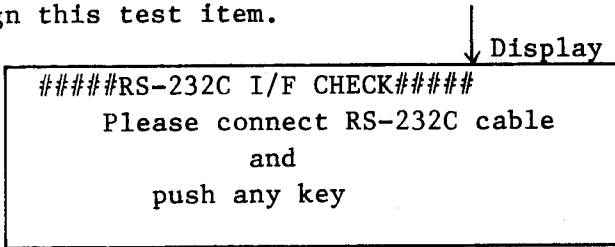

Fasten the RS-232C cable according to the display direction and push the [SPACE] bar.

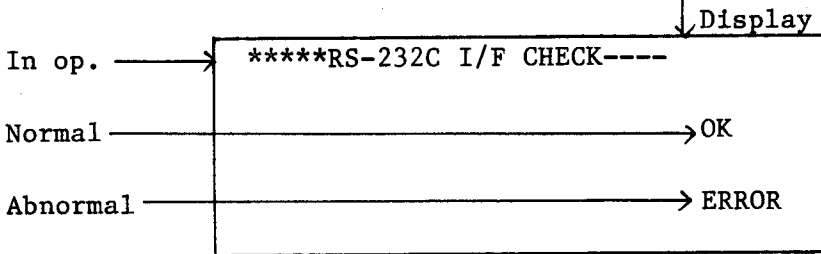
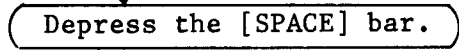

Push the [SPACE] bar after the completion to return to the main menu.

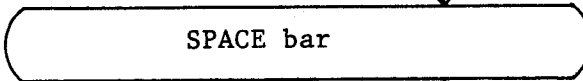

To main menu

8. Timer test

When the main menu item "10" is selected, it permits to set the RTC time, to read the RTC time or test the alarm function.

[Display]

TIMER CHECK

SET TIME YY: MM: DD HH: MM:SS

To set the time, enter the current time.

- YY: Represents last two digits of the year.
- MM: Represents the month in two digits (03, for example)
- DD: Represents the day in two digits.
- HH: Represents hours in two digits.
- MM: Represents minutes in two digits.
- SS: Represents seconds in two digits.

SET OK Y/N

Push [Y] if timer setup is correct. If not, push [N].

TIME = "Time display"

ALARM CHECK --- OK Normal

ERROR Abnormal

NOTE-1: It will take about five seconds to test alarm.

NOTE-2: This test must be done before service check II is done.

9. Key interface test

If "Key interface test" is chosen by entering "10" on the main menu, the control returns to the main menu without doing any action.

The key interface test should be done in the following manner.

i) Push the [BREAK] key

ii) Make sure that the LED on the CAPS LOCK key blinks.

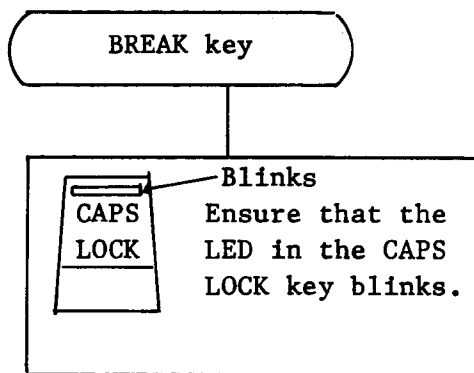

10. Expansion DRAM (MZ-1R22) test

The test procedure will be the same as the RAM test including display action, except that a block in error is indicates with the following symbol.

3: 40000H - 5FFFFH

4: 60000H - 7FFFFH

NOTE:

The memory protect function will not be tested.

11. Expansion VRAM (MZ-1R09) test

The test procedure will be the same as the VRAM test including display action, except that a VRAM plane in error is indicates with the following symbol.

EP0, EP1, EP2

12. 8087 test

[Display]

***** 8087 CHECK ***** ←——In op.

OK ←——Normal

(ERROR)←——Abnormal

The [SPACE] bar has to be pushed after completion of the test to return to the main menu.

°Service check II (file name: T)

After completion of service check I, turn power off, and turn power on in about 10 seconds later to start CP/M-86. After the start of CP/M-96, enter [T] and [CR], which will display the time. Compare the time with the time set in service check I. If matches, the time is correct.

II. MZ-5600 MFD CHECKER INSTRUCTIONS

II-1. General

The MZ-5600 IPL ROM should be replaced by this checker ROM for test of the MZ-5600 mini-floppy disk drive. When power is turned on, it starts to perform physical tests of the MZ-5600 MFD whose contents are as follows:

1) Read test

Continues to read the contents of the specified track. When an error is encountered in a middle of test operation, the machine stops immediately.

2) Write test

Writes the test data on the specified track which will be verified. Upon completion of the verification, the machine stops operation.

3) Seek test

Specified cylinders (tracks) are seeked continuously and repeatedly. Used for 0 track adjustment.

4) Read anyway test

Except that the machine does not stop even if an error is encountered in a middle of test operation, it performs the test identical to the read test above. Used for alignment adjustment.

II-2. ROM exchange procedure and setup

1. Power off the MZ-5600 and turns it upside down.
2. Remove the bottom cover.
3. Take out two chips of IPL ROMs.
4. Mount two checker ROMs on the IPL ROM sockets.
5. Replace the bottom cover back and put the MZ-5600 back in normal position.

See the figure below for the locations of IPL ROMs. Pay attention for the IPL ROM inserted direction.

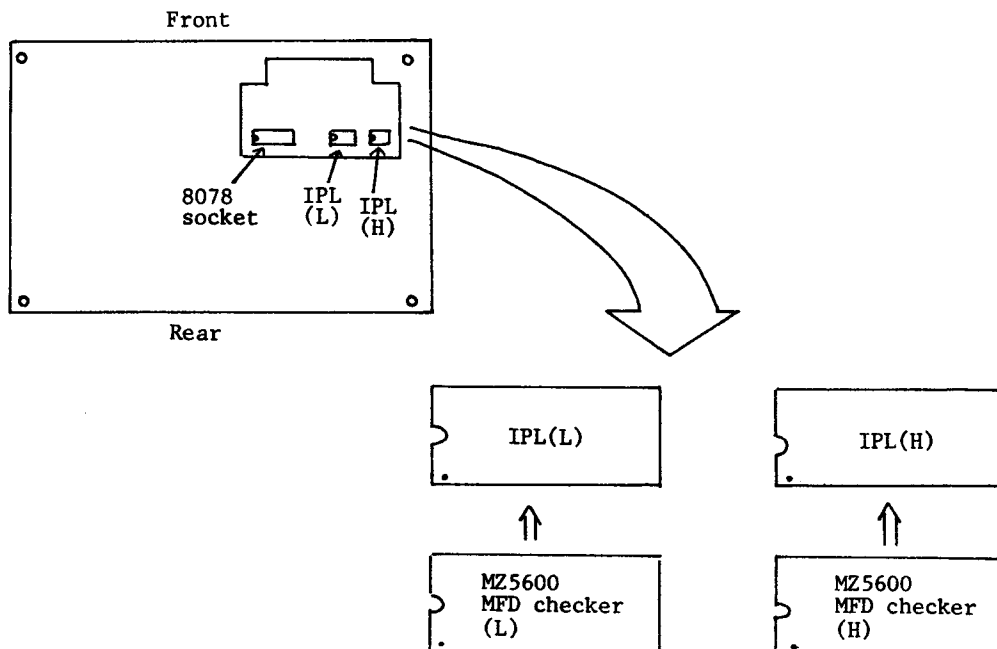

6. Connect the CRT and keyboard to the MZ-5600.
7. Power on the CRT.
8. Power on the MZ-5600. The checker now starts to run.
Use the diskette that has been formatted to use with the MZ-5600.

□-3. Main menu

1. The following main menu appears as soon as the checker program starts.

```
MZ-5600 MINI FLOPPY CHECK

READ CHECK----1
WRITE CHECK---2
SEE CHECK-----3
READ ANYWAY---4

ENTER CHECK NO. _
```

Push a key of desired item (1 - 4). As the specified test item starts to run, test detail will be prompted on the display.

2. Error message

When an error is encountered in a middle of test operation, the following message will be displayed.

*** NO MEDIA/DRIVE ***

Specified drive unit is not in connection or the media is not inserted in the drive unit.

*** RECALIBRATION ERROR ***

Improper execution of head calibration.

*** WRITE ERROR ***

Abnormal end of an FDC write command.

*** READ ERROR ***

Abnormal end of an FDC read command.

*** READ AFTER WRITE ERROR ***

Occurrence of a verify error during read after write check.

*** WRITE PROTECT ***

The media is write protected.

Any key depression will cause the control to return to the main menu, when the above message is displayed.

II-4. Independent test function

1. READ CHECK

- 1) READ CHECK START
TRACK NO. (00 - 79)?_

Specify the track number in two digits of a decimal number.

- 2) SIDE NO. (0 - 1)?_

Specify the side of the media to be tested.

0: Front side (SIDE 0)

1: Reverse side (SIDE 1)

- 3) DRIVE UNIT (A - D)?_

Enter the drive unit name using an upper case alphabet.

- 4) When the drive unit name has been entered, the test program starts to read data in one track (4KB), with the following message on display.

```
READ CHECK START  
HIT ANY KEY FOR ANOTHER CHECK
```

The operation continues until an error is encountered or any key is depressed.

2. WRITE CHECK

- 1) WRITE CHECK START
TRACK NO.(00 - 79)?_

Specify the track number in two digits of a decimal number.

- 2) Specify the side of the media to be tested in the same manner as READ CHECK above.

- 3) Specify the drive name in the same manner as READ CHECK above.

- 4) WRITE DATA (00 - FF)?_

Enter the write data in two digits of a hexadecimal number.

- 5) The test program starts to run immediately after entry of the write data and the first track is written (4KB) with the following message on display.

```
WRITE CHECK START
```

When the test has been completed successfully, the following message will be displayed.

WRITE CHECK OK
HIT ANY KEY FOR ANOTHER CHECK

NOTES:

°Since the specified data are actually written on the floppy disk, it will destroy the data currently existing. So, do not use the floppy disk such as the master disk.

· Depression of the CARRIAGE RETURN key in Items 1), 2), 3), or 4) will cause the control to return to the main menu.

3. SEEK CHECK

- 1) SEEK CHECK START
TRACK NO.(00 - 79)?_

Specify the starting track number in two digits of a decimal number.

- 2) The control will come to ask for the track number again.

TRACK NO. (00 - 79)?_

Specify the ending track number in two digits of a decimal number.

- 3) Specify the drive name same as in READ CHECK above.

- 4) SEEK CHECK START
HIT ANY KEY FOR ANOTHER CHECK

With the above message on display, it will continue and repeat the seek test between tracks specified.

4. READ ANYWAY

- 1) READ ANYWAY
TRACK NO. (00-79)?_

Except for the above message, this test item is identical to READ CHECK. But, operation will continue in this test even if an error has been occurred.

SHARP

SHARP CORPORATION

Industrial Instruments Group
Reliability & Quality Control Department
Yamatokoriyama, Nara 639-11, Japan

1984 November Printed in Japan (ST)